



# 標準ゲインホーンアンテナ

## Specification



### Model : MSGH-WR12-25

Frequency Range(GHz)	60.0 - 90.0
Gain(dB)	25 Typ.
3dB Beamwidth(deg)	10 Typ.
Waveguide	WR12
Material	Cu
Output	FUGP740(UG-387/U)
Size(mm)	32x26x82
Net Weight(Kg)	0.05 Around

## Waveguide Output

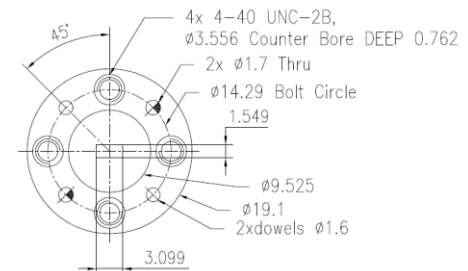
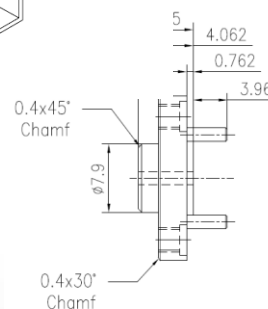
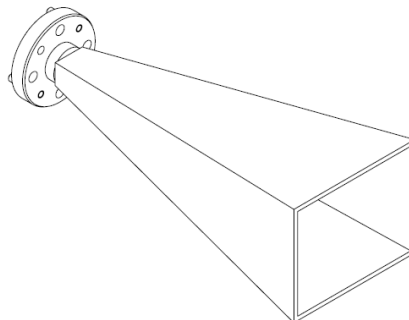
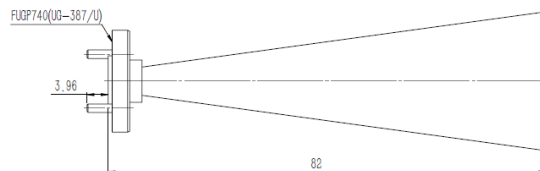
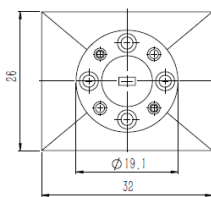

FUGP740  
(equivalent to UG-387/U)

## Antenna Gain (typ.)

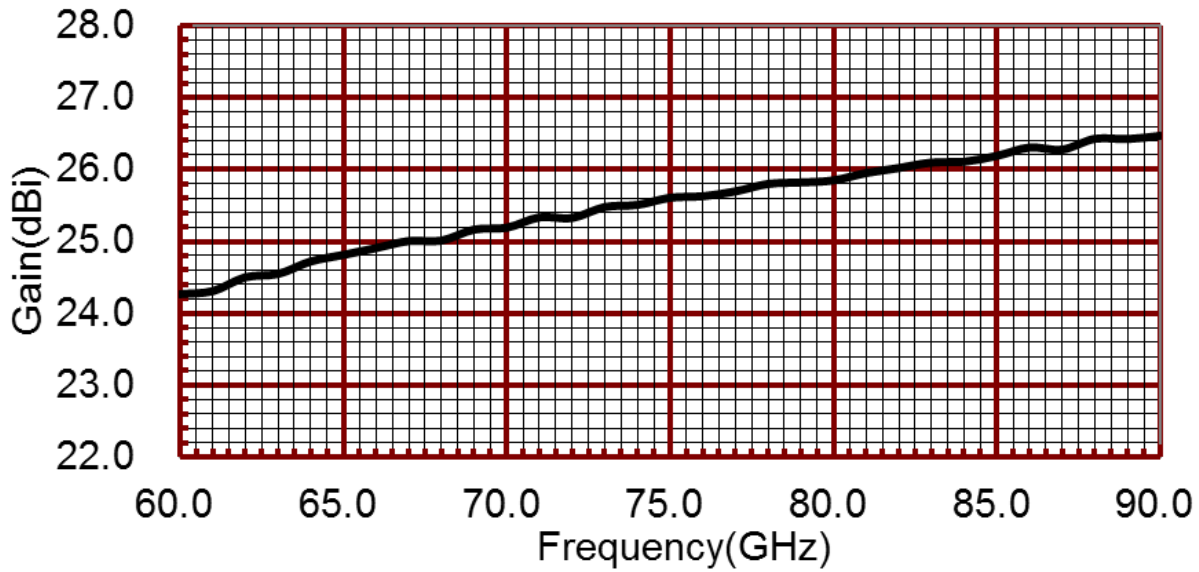

Frequency(GHz)	Gain(dBi)	Antenna Factor(dB/m)
60	24.27	41.51
62	24.50	41.56
64	24.72	41.61
66	24.91	41.69
68	25.01	41.85
70	25.19	41.92
72	25.33	42.03
74	25.51	42.09
76	25.63	42.20
78	25.80	42.25
80	25.85	42.42
82	26.02	42.46
84	26.11	42.59
86	26.31	42.59
88	26.43	42.67
90	26.47	42.83

## Radiation Patterns (typ.)

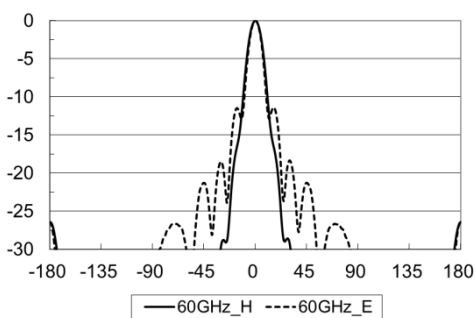

60GHz

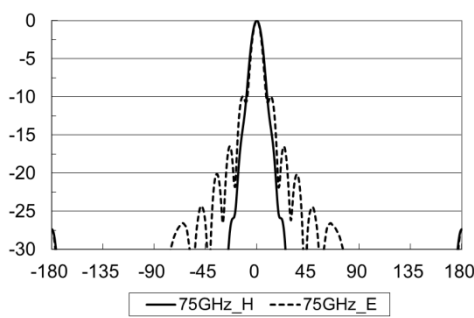

75GHz

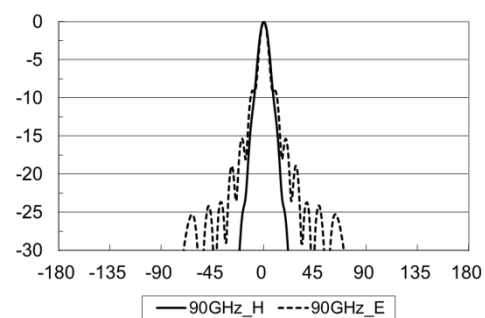

90GHz

お問い合わせ先：

マイクロウェーブファクトリー株式会社

東京都町田市原町田3-11-9

技術営業部

TEL : 042-727-8008 FAX : 042-727-8074

E-MAIL : sales@mwf.co.jp URL : <https://www.mwf.co.jp/>



Microwave Factory Co.,Ltd.