



# ブロードバンドホーンアンテナ

## 製品概要 or 主要特性

### Model : MDH0218



Frequency Range(GHz)	2 - 18
Gain(dBi)	5 - 14Typ.
Polarization	Linear
VSWR	3.0:1 Typ.
Connector	SMA - Female
Power Handling(W)	1W Max. CW
Net Weight(Kg)	0.4 Around
Size(mm)	100x60x110 Typ.

## 外形寸法図 (mm)

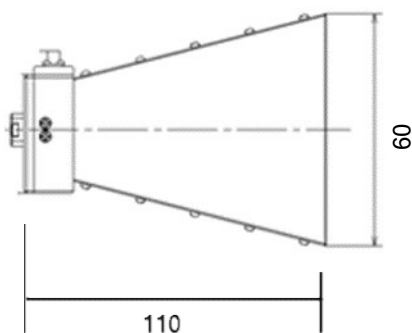
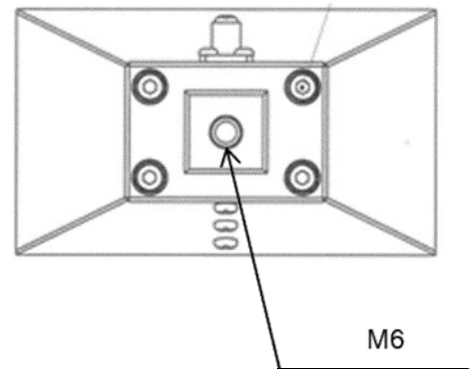
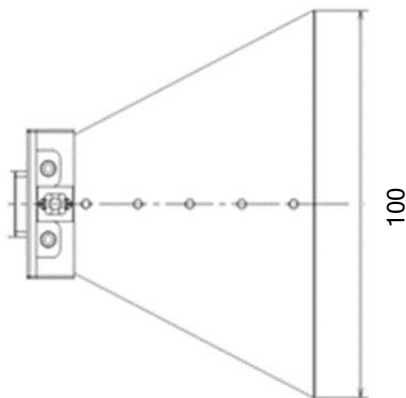

## アンテナパターン (Typ.)

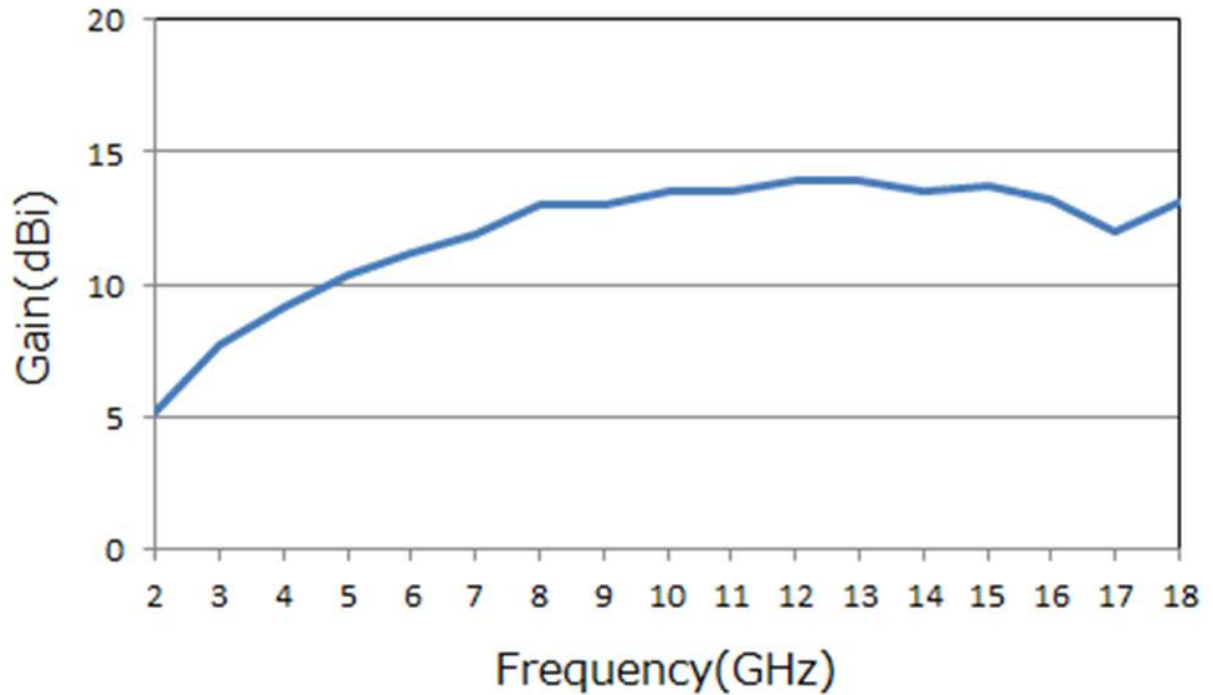

## 輻射パターン (Typ.)

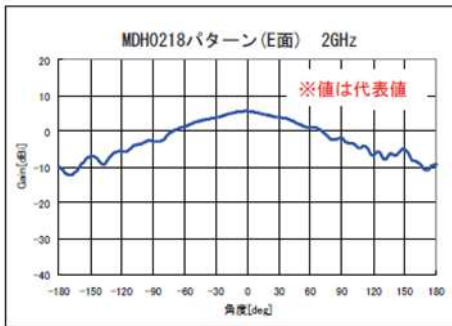

2GHz(E面)

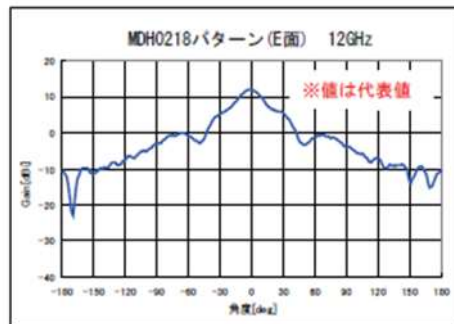

12GHz(E面)

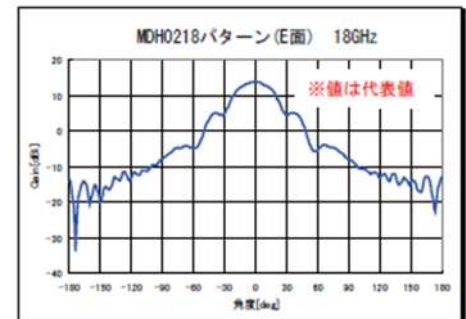

18GHz(E面)

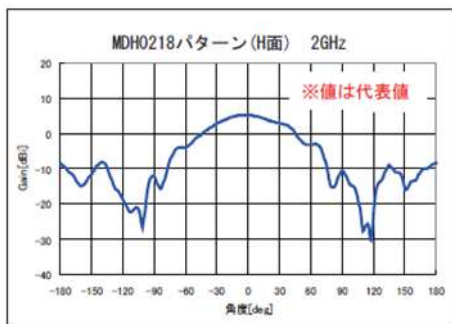

2GHz(H面)

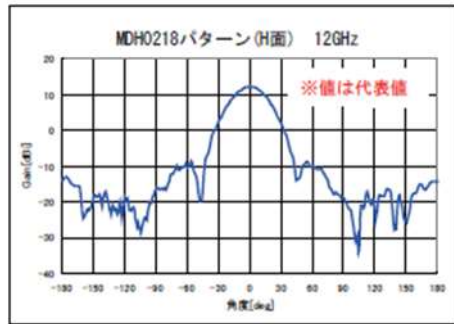

12GHz(H面)

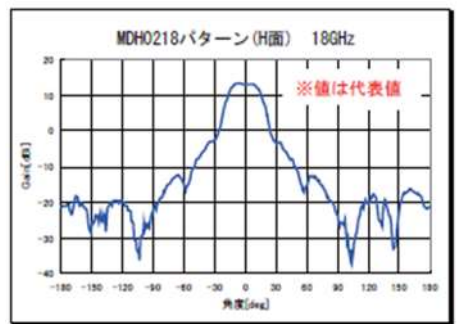

18GHz(H面)