



ダブルリッジホーンアンテナ

Model : MDH00718

主要特性



Frequency Range(GHz)	0.7 - 18.0
Gain(dB)	12 Typ.
Polarization	Linear
VSWR	2.0:1 Typ.
Impedance	50Ω
Connector	N-F or SMA-F
Size(mm)	244 x 160 x 228

外形寸法図 (mm)

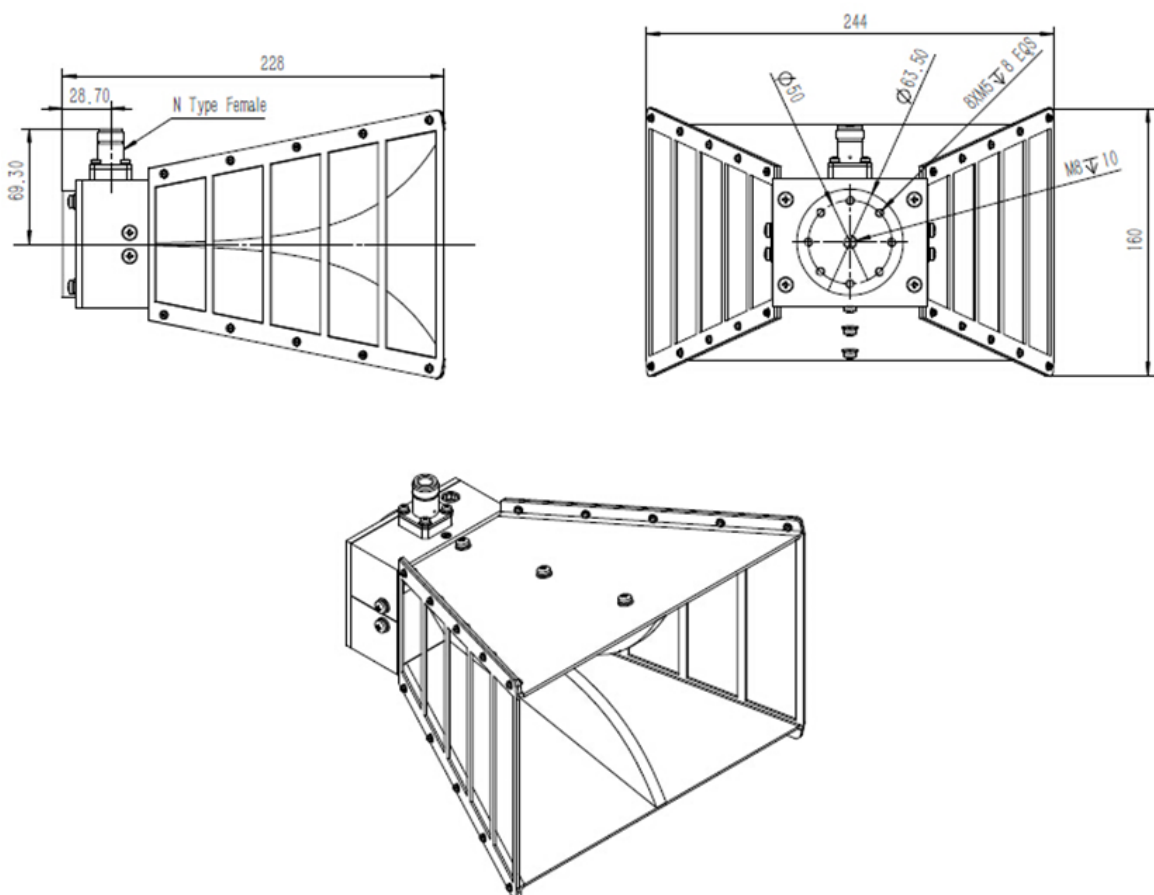

アンテナパターン (Typ.)

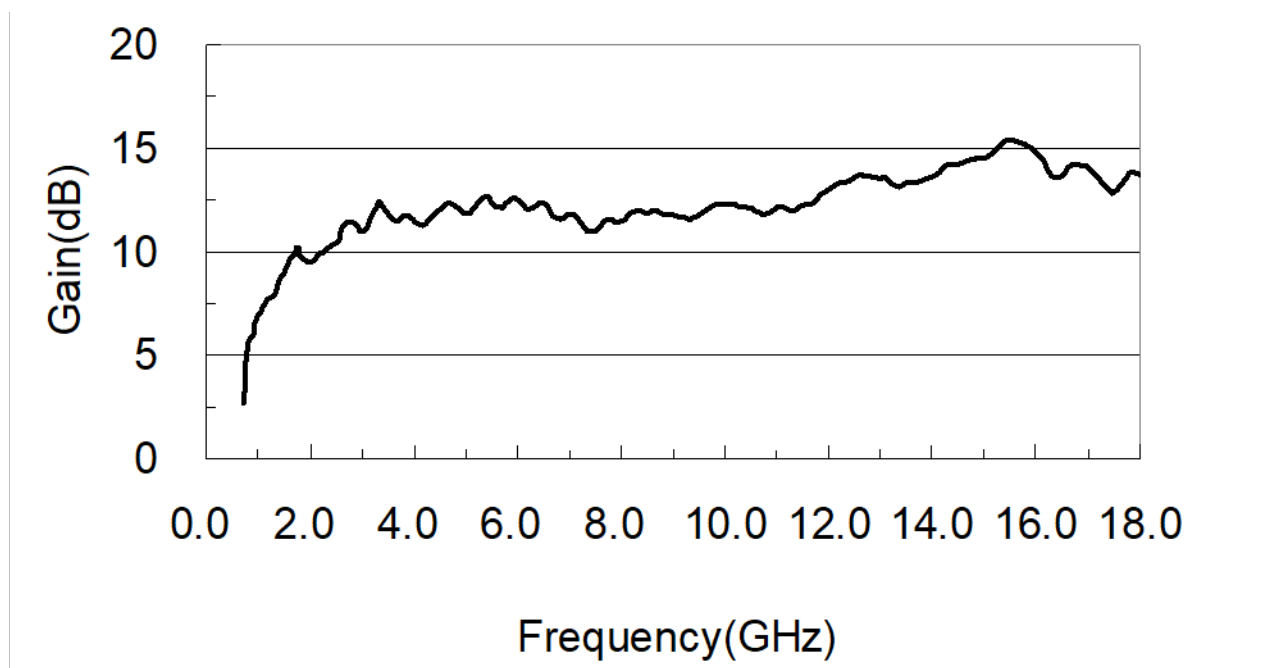

輻射パターン (Typ.)

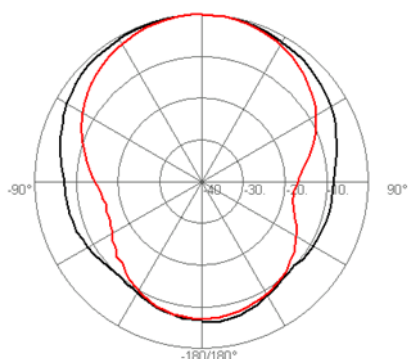

700 MHz

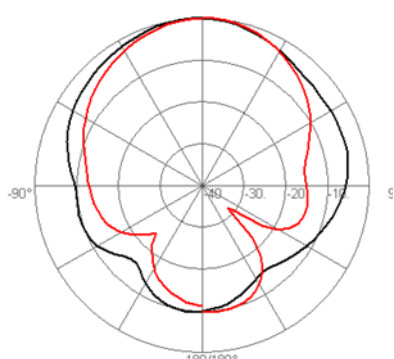

1GHz

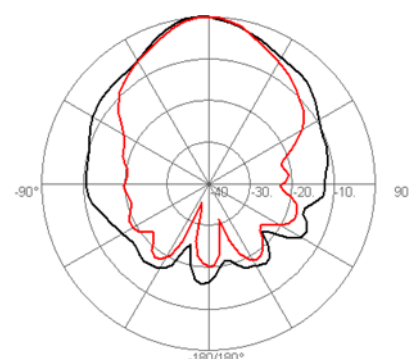

3GHz

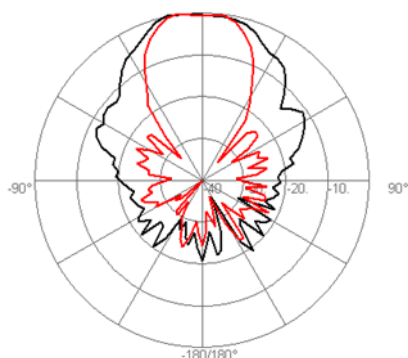

8 GHz

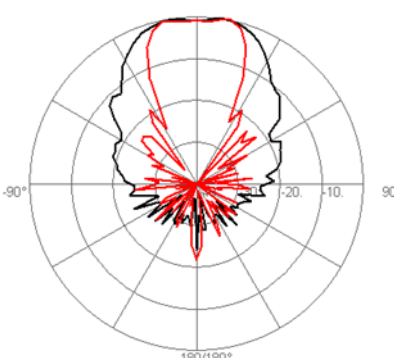

12GHz

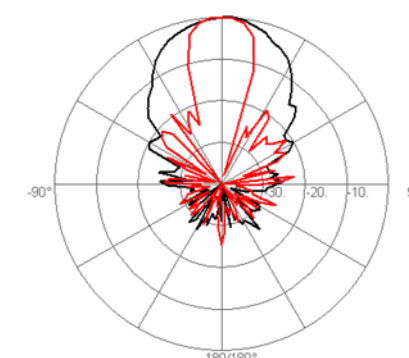

18GHz